

1) Inner Box Drawing

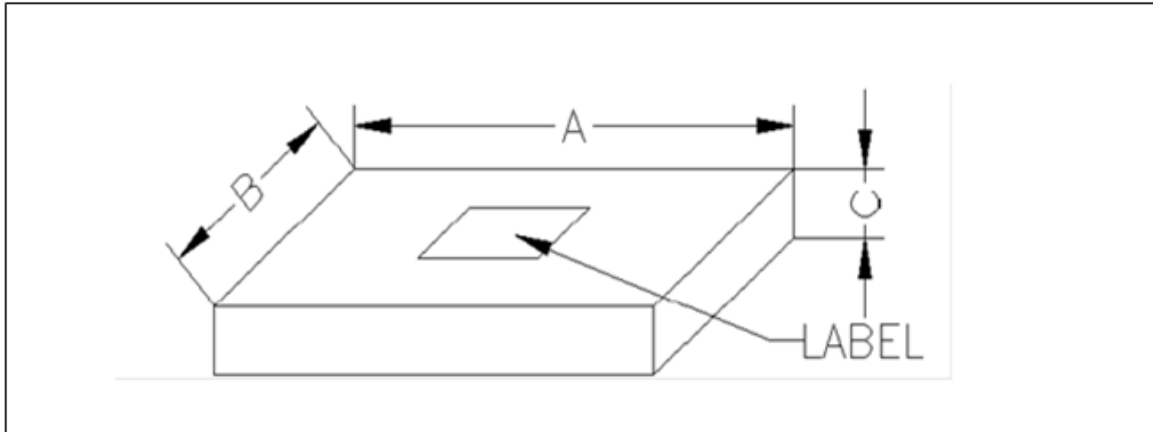

2) Inner Box Label

TYPE: XXXXXXXX

P/N: XXXXXXXXXXXX-XXXX-XXXX---Yangjie Internal Control Part No.

Exp. XXXXXX -XX-XXXXX

P/O: XXXXXXXXXXXX----Purchase Order No by Distributor

Exp. CDR1106300050

Means this is the 50th orders on June. 30 2011 in Yangjie system.

Q'TY (PCS): XXXX---Qty of Inner Box

LOT NO.: XXXXXXXX---Yangjie Internal Tracking No.

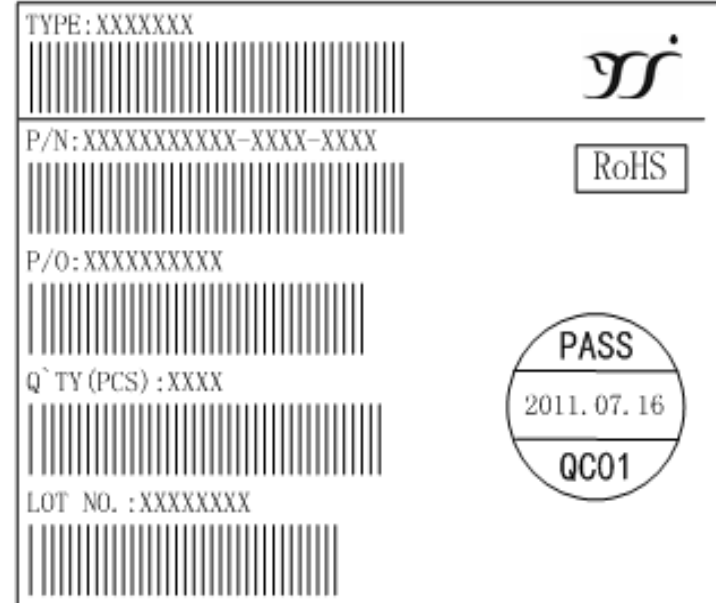

3) Outer Carton Drawing

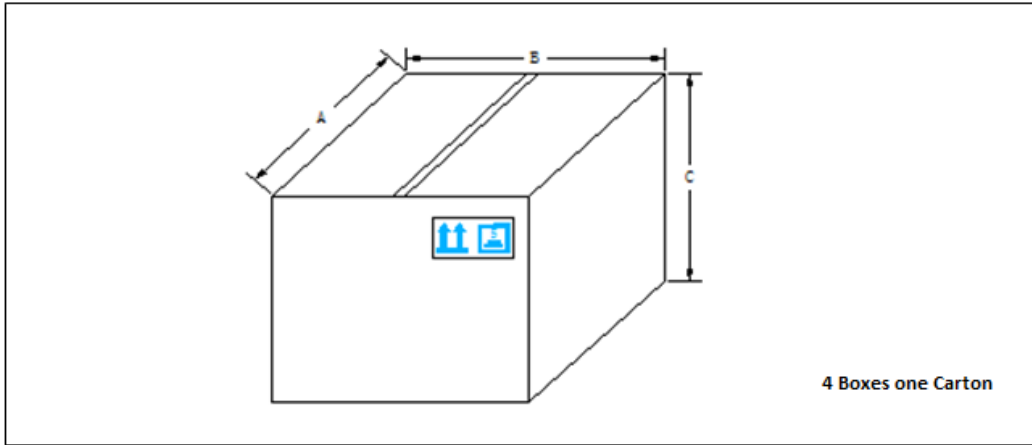

4) Outer Carton Label

TYPE: XXXXXXXX

P/N: XXXXXXXXXXXX-XXXX-XXXX---Yangjie Internal Control Part No.

Exp. XXXXXX -XX-XXXXX

P/O: XXXXXXXXXXXX----Purchase Order No by Distributor.

Q'TY (PCS): XXXX---Qty of Outer Carton

LOT NO.: XXXXXXXX---Yangjie Internal Tracking No.

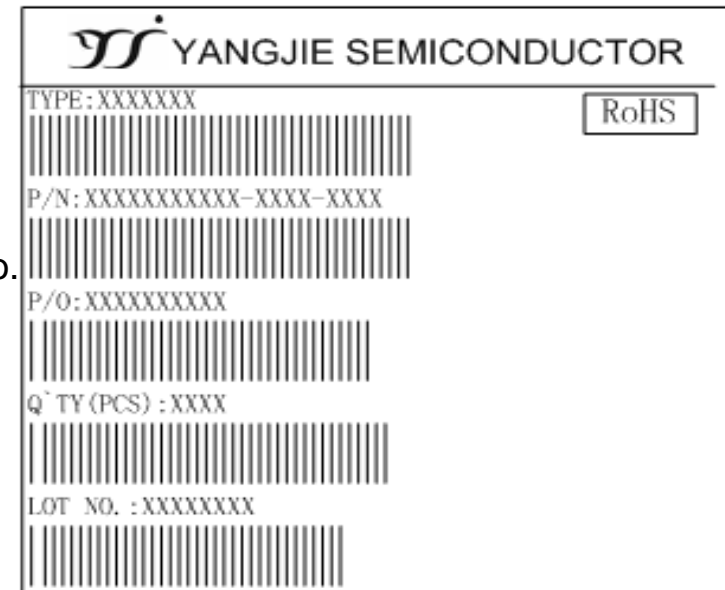

1) Tube Drawing and Size

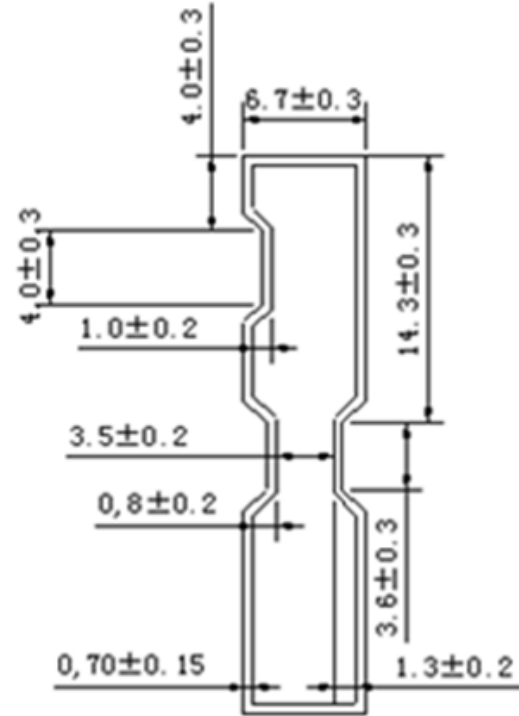
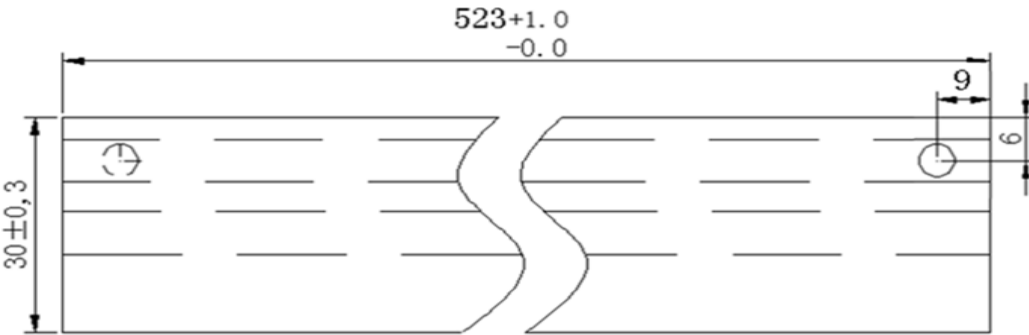

Notes: Unmarked Tolerance: ± 0.25

Tube Thickness: 0.5 ± 0.1

Unit: mm

2) Inner Box

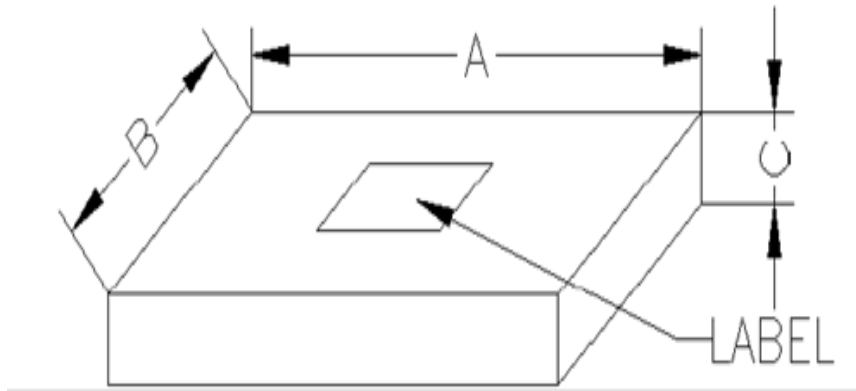

3) Inner Box Label

TYPE: XXXXXX

P/N: XXXXXXXXXXX-XXXX-XXXX---Yangjie Internal Control Part No.

Exp. XXXXXX -XX-XXXX







P/O: XXXXXXXXXXX----Purchase Order No by Distributor

Exp. CA1106300050

Means this is the 50th orders on June. 30 2011 in Yangjie system.

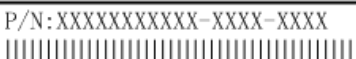
Q'TY (PCS): XXXX---Qty of Inner Box

LOT NO.: XXXXXXXX---Yangjie Internal Tracking No.

TYPE: XXXXXX	
	
P/N: XXXXXXXXXXX-XXXX-XXXX	
	
P/O: XXXXXXXXXXX	
	
Q'TY (PCS) : XXXX	
	
LOT NO. : XXXXXXXX	
	

4) Outer Carton Drawing

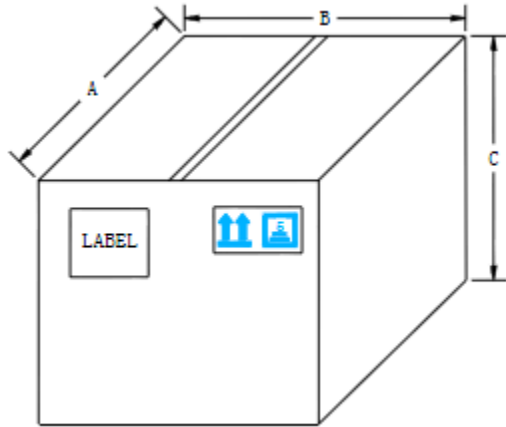

5) Outer Carton Label

TYPE: XXXXXX

P/N: XXXXXXXXXXXX-XXXX-XXXX---Yangjie Internal Control Part No.

Exp. XXXXXX -XX-XXXXX

P/O: XXXXXXXXXXXX----Purchase Order No by Distributor

Exp. CA1106300050

Means this is the 50th orders on June. 30 2011 in Yangjie system.

Q'TY (PCS): XXXX---Qty of Outer Carton

LOT NO.: XXXXXXXX---Yangjie Internal Tracking No.

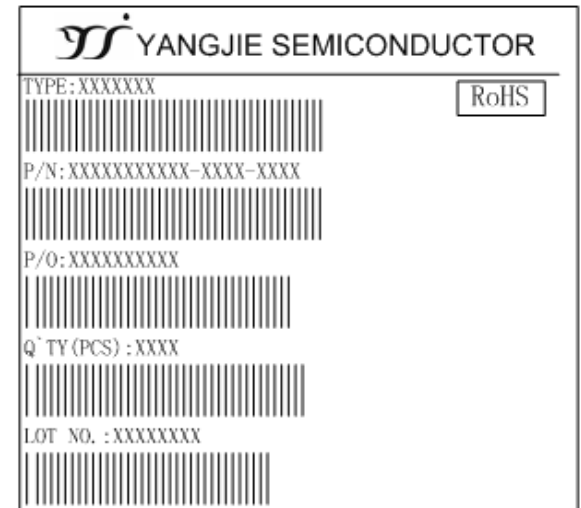

1) Tape Drawing and Size

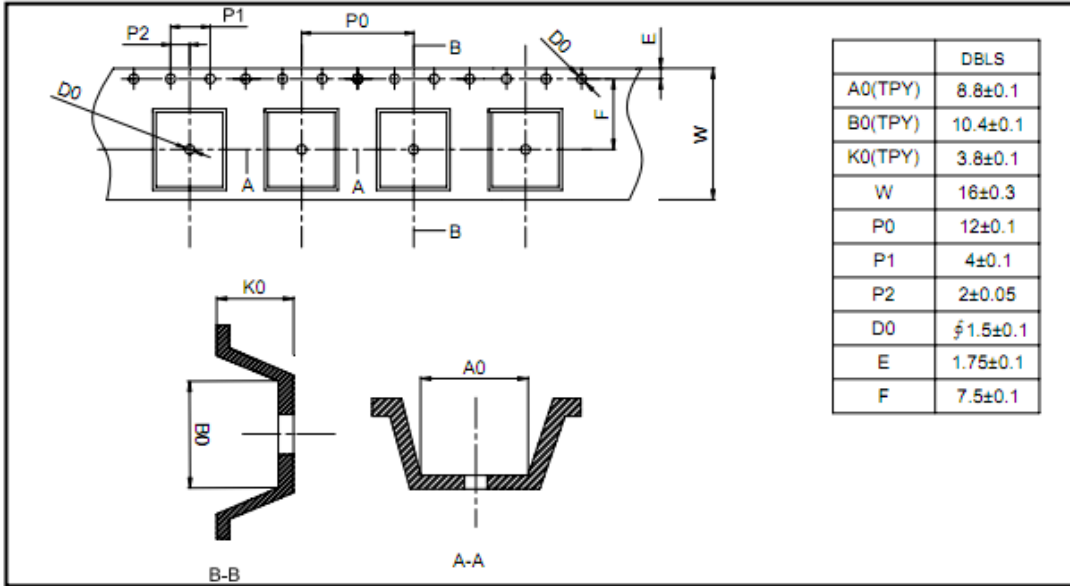

2) Reel Drawing and Size

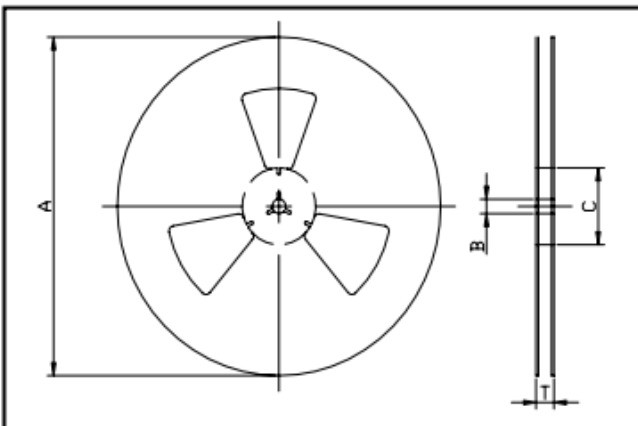

Tape Size	Product Type	A MAX	B ±0.5	C MIN	T MAX
13"	DBS	330 (13.0)	14 (0.551)	100 (3.94)	20 (0.79)

3) Inner Box Drawing

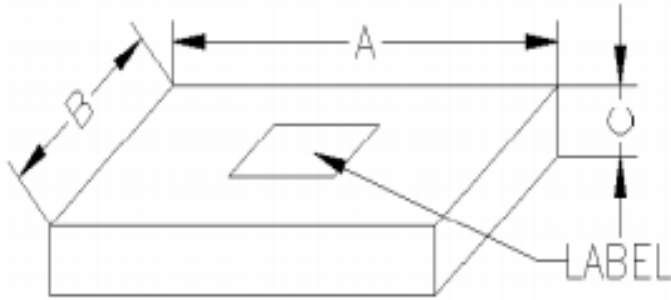

4) Inner Box Label

TYPE:XXXXXX

Code: XXXX-Date Code

Exp. 05H07

Q'TY (PCS): XXXX---Qty of Inner Box

Exp. 3000

LOT NO.: XXXXXXXX---Yangjie Internal Tracking No. in ERP.

Exp. 10080110016

10 means the product voltage profile;

0801 means the date of process card B;

100 means the card serial no;16 means the staff number.

TYPE: DB157S	
	
<hr/>	
CODE:05H07	
	
Q'TY(PCS): 3000	
	
LOT NO:10080110016	
	

1) Tape Drawing and Size

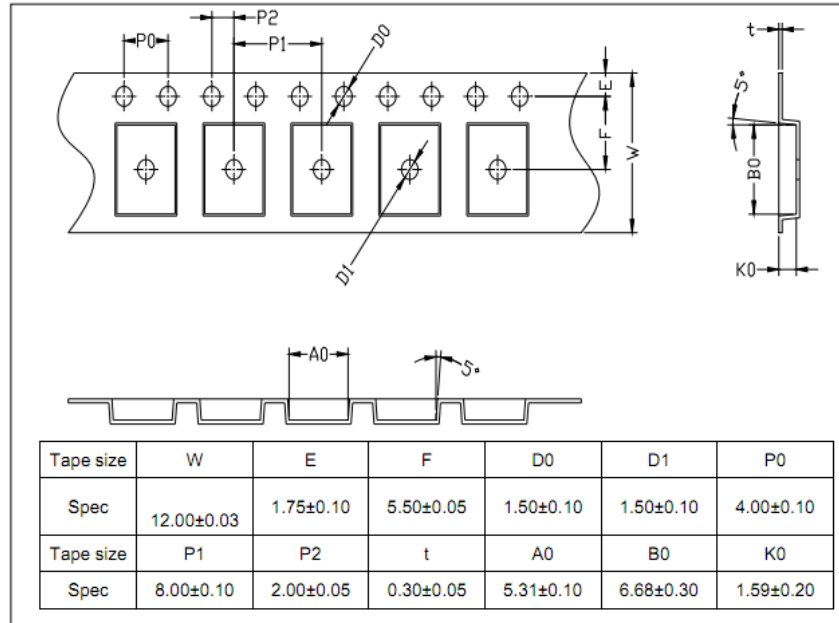

2) Reel Drawing and Size

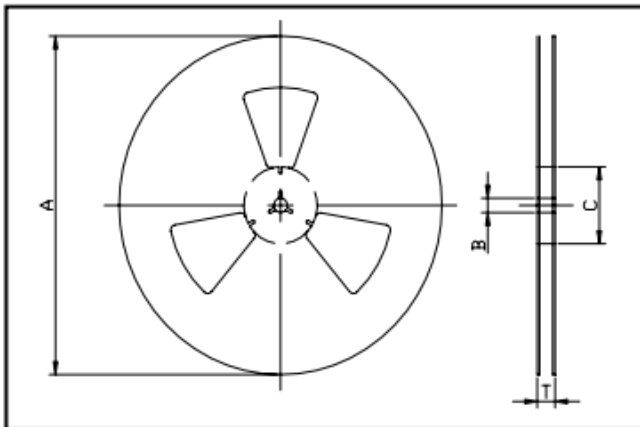

Tape size	Product type	A ±1	B ±0.5	C +1/-0.5	T ±0.5
13"	ABS	330 (13.0)	14 (0.551)	75 (2.952)	18.4 (0.724)

ABS

YANGZHOU YANGJIE ELECTRONIC TECHNOLOGY CO.,LTD.

3) Reel Label

TYPE:XXXXXX





P/N: XXXXXXXXXXX-XXXX-XXXX

Yangjie Internal Control Part No.

P/O: XXXXXXXXXXX----Purchase Order No by Distributor.

Q'TY (PCS): XXXX---Qty of Reel

LOT NO.: XXXXXXXX---Yangjie Internal Tracking No. .

TYPE: XXXXXXXX 	
P/N: XXXXXXXXXXX-XXXX-XXXX 	RoHS
P/O: XXXXXXXXX 	 <p>PASS 2011. 07. 16 QC01</p>
Q'TY (PCS) : XXXX 	
LOT NO. : XXXXXXXX 	

4) Inner Box Drawing

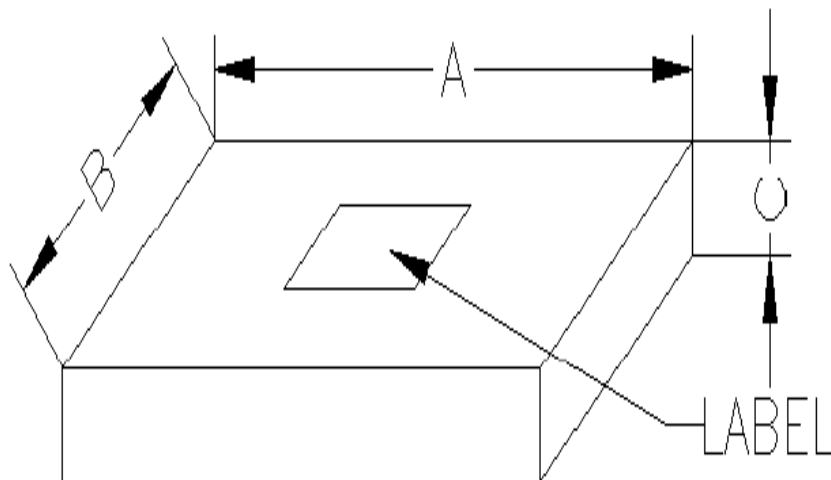

5) Outer Carton Drawing

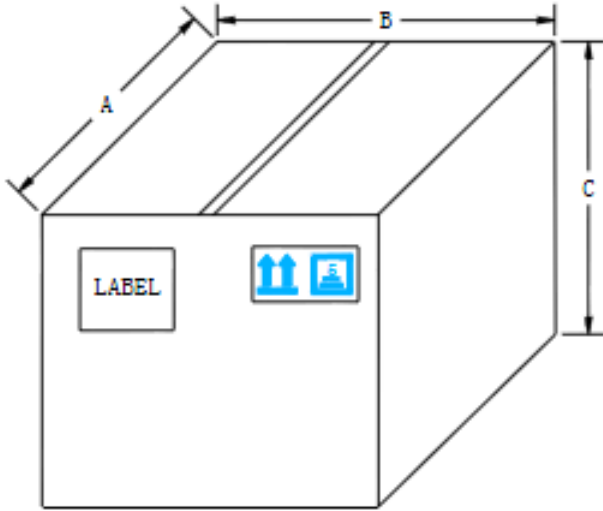

6) Outer Carton Label

TYPE:XXXXXX

P/N: XXXXXXXXXXX-XXXX-XXXX

Yangjie Internal Control Part No.

P/O: XXXXXXXXXXX----Purchase Order No by Distributor

Q'TY (PCS): XXXX---Q'ty of Outer Carton

LOT NO.: XXXXXXXX---Yangjie Internal Tracking No.

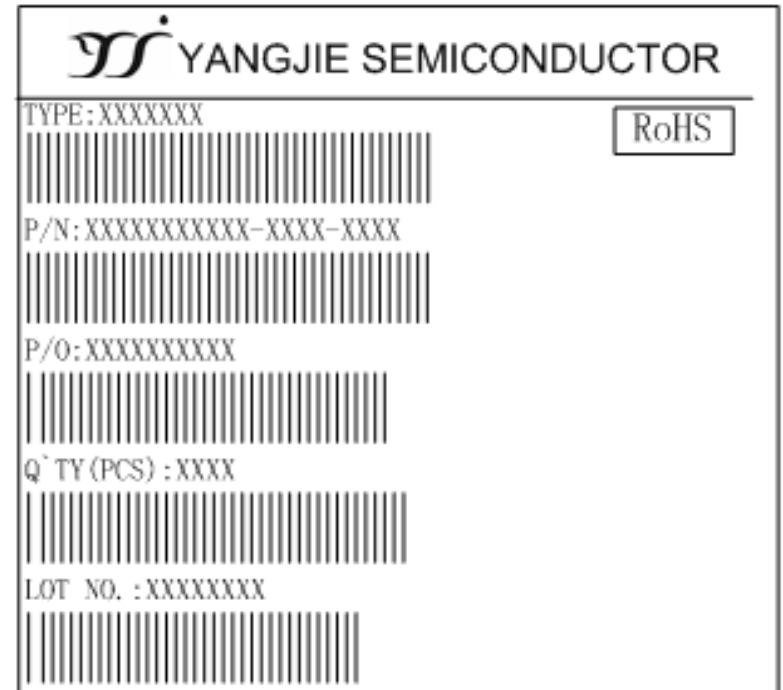

1) Tape Drawing and Size

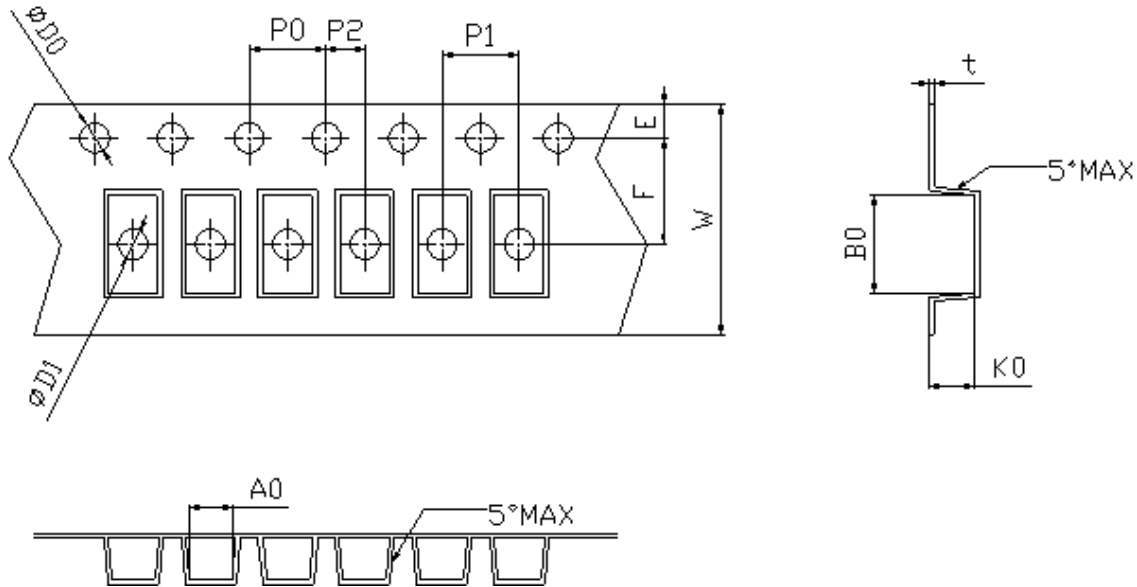

Symbol	W	E	F	D0	D1	P0
Spec	12.0±0.1 5	1.75±0.1 0	5.50±0.0 5	1.55±0.0 5	1.55±0.0 5	4.00±0.1 0
Symbol	P1	P2	t	A0	B0	K0
Spec	4.00±0.1 0	2.00±0.0 5	0.24±0.0 5	2.79±0.1 0	5.33±0.1 0	2.36±0.0 5

Unit: mm

2) Reel Drawing and Size

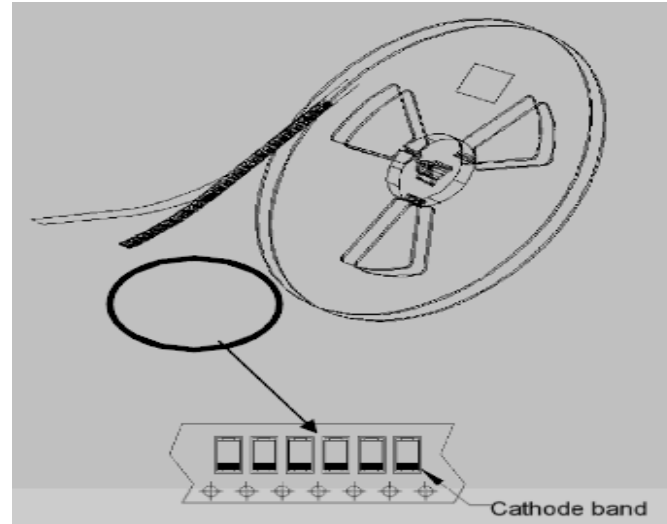
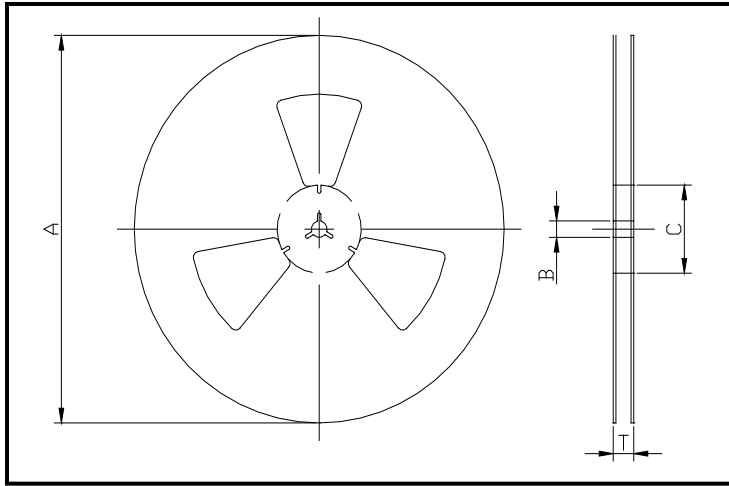

Reel size	Product type	A ±1	B ±0.5	C +1/-0.5	T ±0.5
13"	SMA	330 (13.0)	14 (0.551)	75 (2.952)	18.4 (0.724)

3) Reel Label

TYPE:XXXXXX









P/N: XXXXXXXXXXX-XXXX-XXXX

Yangjie Internal Control Part No.

P/O: XXXXXXXXXXX----Purchase Order No by Distributor

Q'TY (PCS): XXXX---Qty of Reel

LOT NO.: XXXXXXXX---Yangjie Internal Tracking No.

TYPE: XXXXXXX	
	
P/N: XXXXXXXXXXX-XXXX-XXXX	
	
P/O: XXXXXXXXXXX	
	
Q`TY (PCS) : XXXX	
	
LOT NO. : XXXXXXX	
	

4) Inner Box Drawing

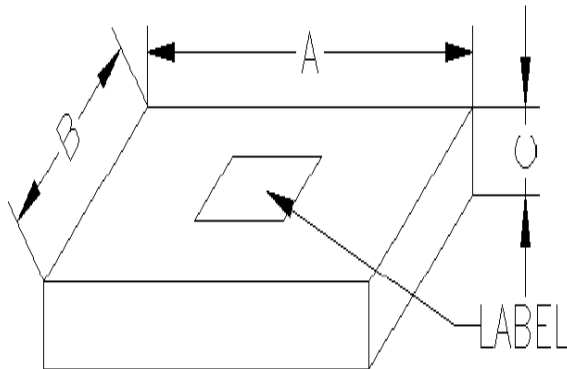

5) Outer Carton Drawing

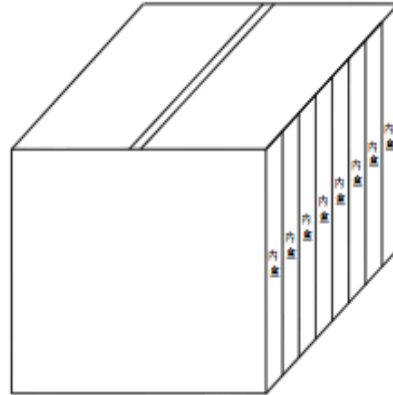
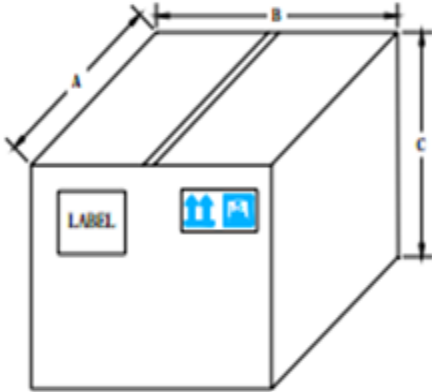

6) Outer Carton Label

TYPE:XXXXXX







P/N: XXXXXXXXXXX-XXXX-XXXX

Yangjie Internal Control Part No.

P/O: XXXXXXXXXXX----Purchase Order No by Distributor

Q'TY (PCS): XXXX---Qty of Outer Carton

LOT NO.: XXXXXXXX---Yangjie Internal Tracking No.

 YANGJIE SEMICONDUCTOR	
TYPE: XXXXXXXX	RoHS
	
P/N: XXXXXXXXXXX-XXXX-XXXX	
	
P/O: XXXXXXXXXXX	
	
Q' TY (PCS) : XXXX	
	
LOT NO. : XXXXXXXX	
	

1) Tube Drawing and Size

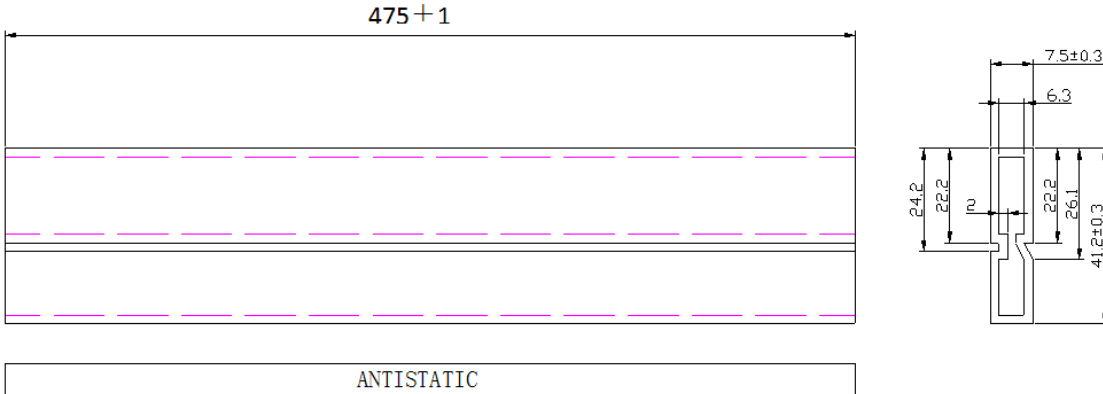

Notes: Unmarked Tolerance: ± 0.25

Tube Thickness: 0.5 ± 0.1

Unit: mm



2) Inner Box

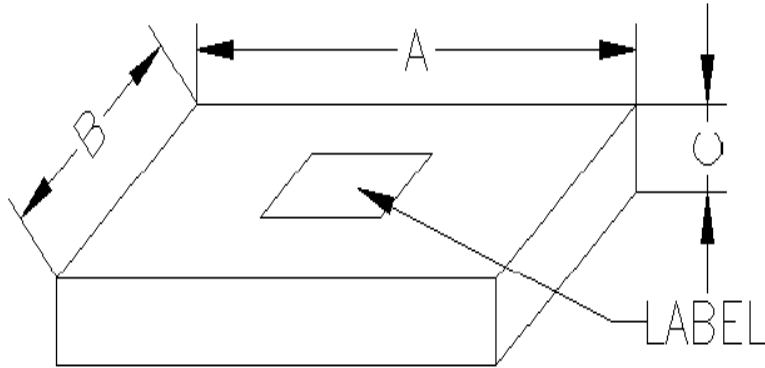

3) Inner Box Label

TYPE: XXXXX









P/N: XXXXXXXXXXX-XXXX-XXXX

Yangjie Internal Control Part No.

P/O: XXXXXXXXXXX----Purchase Order No by Distributor

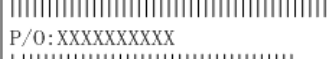
Q`TY (PCS): XXXX---Qty of Inner Box

LOT NO.: XXXXXXXX---Yangjie Internal Tracking No.

TYPE: XXXXXXX	
	
P/N: XXXXXXXXXXX-XXXX-XXXX	
	
P/O: XXXXXXXXXXX	
	
Q`TY (PCS) : XXXX	
	
LOT NO. : XXXXXXXX	
	

4) Outer Carton Drawing

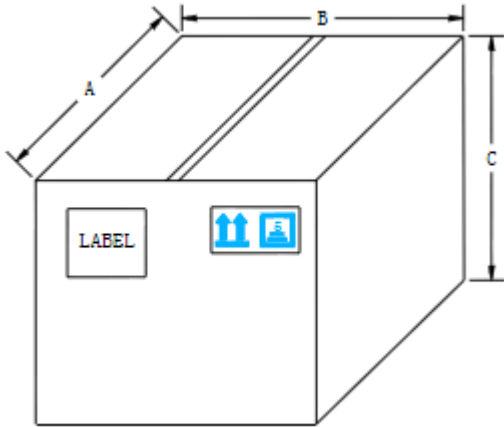

5) Outer Carton Label

TYPE: XXXXX

P/N: XXXXXXXXXXX-XXXX-XXXX

Yangjie Internal Control Part No.

P/O: XXXXXXXXXXX----Purchase Order No by Distributor

Q'TY (PCS): XXXX---Qty of Outer Box

LOT NO.: XXXXXXXX---Yangjie Internal Tracking No.

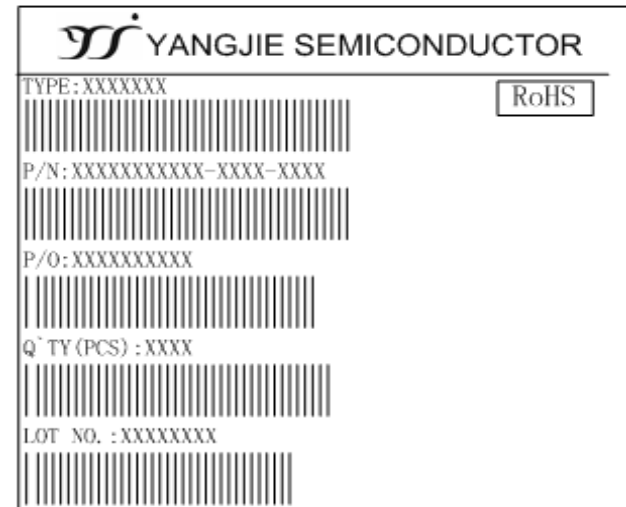

1) Inner Box Drawing

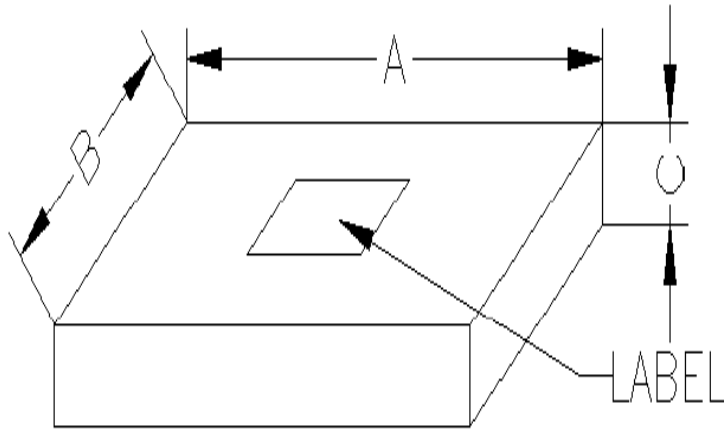

2) Inner Box Label

TYPE: XXXXX





P/N: XXXXXXXXXXXX-XXXX-XXXX

Yangjie Internal Control Part No.

P/O: XXXXXXXXXXXX----Purchase Order No by Distributor

Q'TY (PCS): XXXX---Qty of Inner Box

LOT NO.: XXXXXXXXX---Yangjie Internal Tracking No.

 YANGJIE SEMICONDUCTOR	
TYPE: XXXXXXX	RoHS
	
P/N: XXXXXXXXXXXX-XXXX-XXXX	
	
Q`TY (PCS) : XXXX	
	
LOT NO. : XXXXXXXXXXXX	
	

3) Outer Carton Drawing

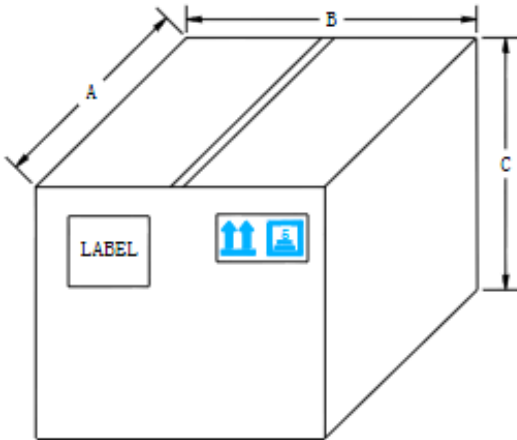

4) Outer Carton Label

TYPE: XXXXX

P/N: XXXXXXXXXXX-XXXX-XXXX

Yangjie Internal Control Part No.

P/O: XXXXXXXXXXX----Purchase Order No by Distributor

Q'TY (PCS): XXXX---Qty of Outer Box

LOT NO.: XXXXXXXX---Yangjie Internal Tracking No.

